

## Etiketten für Ketten

Labels for chains

Étiquettes pour chaînes



- B** Anzahl Bahnen |  
Number of rows |  
Nombre de poses
- BB** Bahnbreite |  
Width of row |  
Largeur de la bande
- T** Etikettenvorschub (Zoll) |  
Label feed (inch) |  
Avance des étiquettes (pouce)
-  Klassische Etiketten für die manuelle  
Beschriftung | Classic labels for  
writing on by hand | Étiquettes clas-  
siques pour inscription manuelle
- \*** Mit durchgestanzten Löchern |  
With punched holes |  
Avec des trous entièrement percés

**35 841\***

B = 1, BB = 60 mm

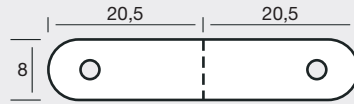

**45 852\***

B = 1, BB = 100 mm, T = 3/6"

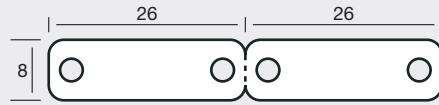

**44 1049\***

B = 1, BB = 80 mm, T = 3/6"

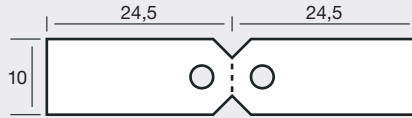

**44 1049/1\***

B = 1, BB = 70 mm, T = 3/6"

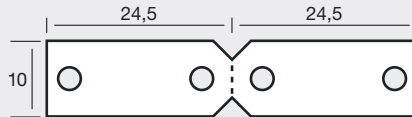

**45 1070\***

B = 1, BB = 100 mm, T = 3/6"

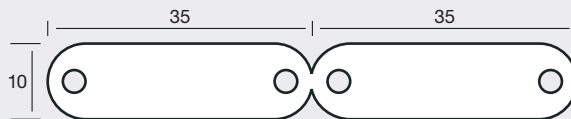

**45 1270/1\***

B = 1, BB = 90 mm, T = 3/6"

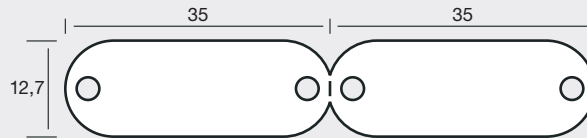

**45 1270/3\***

B = 1, BB = 120 mm, T = 3/6"

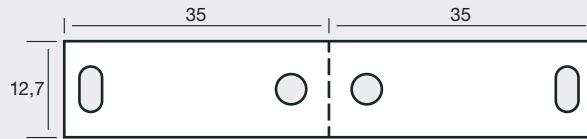

**45 1276\***

B = 1, BB = 120 mm, T = 3/6"

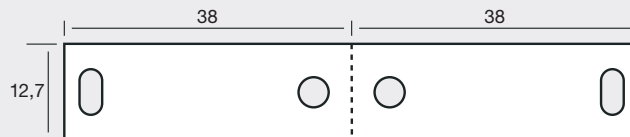

**45 1467\***

B = 1, BB = 100 mm, T = 4/6"

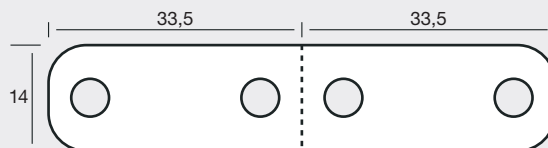

**35 1425\***

B = 2, BB = 80 mm

B = 1, BB = 40 mm

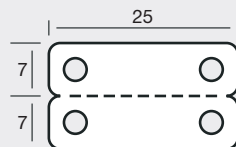

**35 1626\***

B = 1, BB = 60 mm

Lochabstand 20 mm

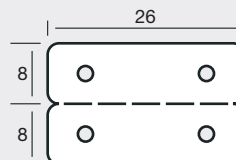

**35 1626/1\***

B = 1, BB = 60 mm

Lochabstand 16 mm

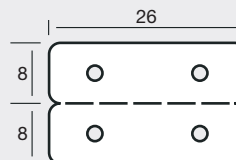

**45 2032\***

B = 1, BB = 60 mm, T = 6/6"  
 passend für KLING-Laden |  
 suitable for KLING-trays |  
 convient aux plateaux  
 de KLING

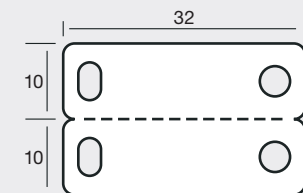

**35 2138\***

B = 2, BB = max. 110 mm

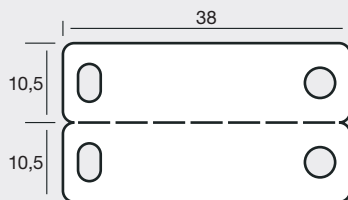

**45 2234\***

B = 2, BB = 120 mm, T = 6/6"

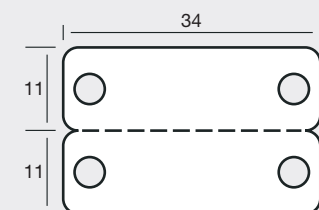

**45 2235\***

B = 2, BB = 120 mm, T = 6/6"  
 Lochabstand 1 mm vom  
 Rand |  
 1 mm distance from hole  
 to margin |  
 Espacement des trous à  
 1 mm de bord

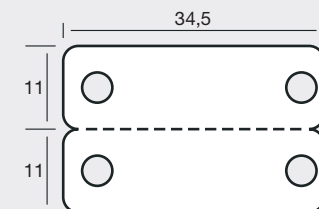

**45 2241\***

B = 2, BB = 110 mm, T = 6/6"

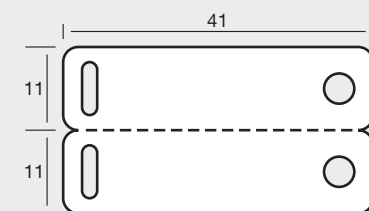

**45 2241/1\***

B = 1, BB = 80 mm, T = 6/6"

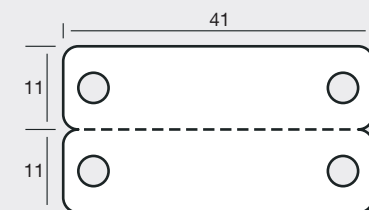

**45 2241/2\***

B = 2, BB = 100 mm, T = 6/6"

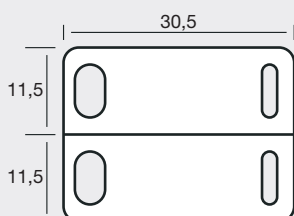

**45 2330\***

B = 3, BB = 120 mm, T = 6/6"

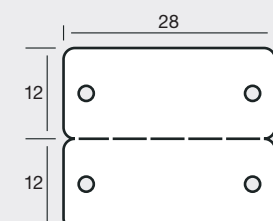

**35 2428\***

B = 1, BB = 40 mm

**45 2432\***

B = 1, BB = 60 mm, T = 7/6"

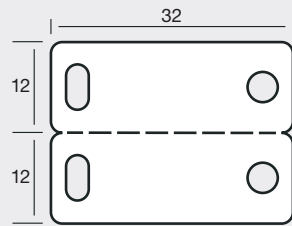

**35 2435\***

B = 2, BB = 100 mm

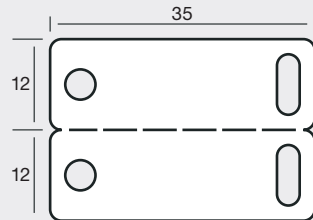

**45 2435/1\***

B = 2, BB = 100 mm, T = 6/6"

**45 2435\***

B = 1, BB = 60 mm, T = 6/6"

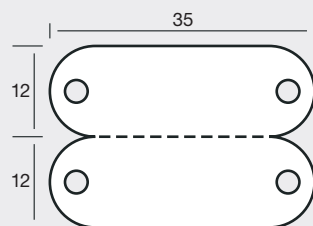

**35 2842/1\***

B = 2, BB = max. 110 mm  
EAN-13

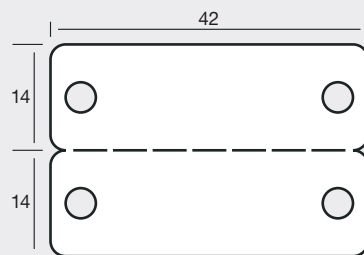

**35 2842/2\***

B = 2, BB = max. 110 mm  
EAN-13

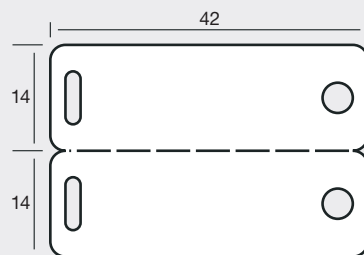

**45 1923\***

B = 4, BB = 130 mm, T = 6/6"

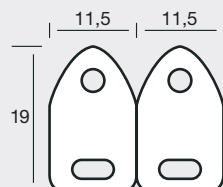

**45 2524\***

B = 1, BB = 60 mm, T = 6/6"

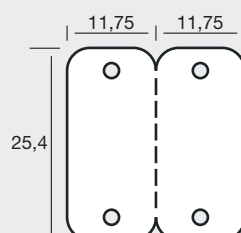

**45 3042\***

B = 1, BB = 70 mm, T = 8/6"

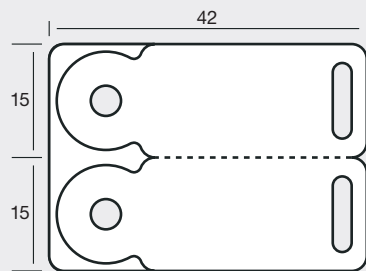

**45 3830\***

B = 2, BB = 100 mm, T = 12/6"

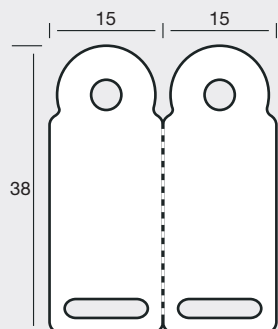

**45 3535\***

B = 1, BB = 60 mm, T = 9/6"

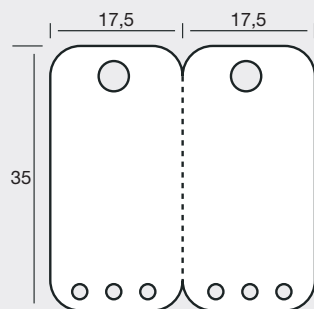

**45 2282\***

B = 1, BB = 100 mm, T = 6/6"

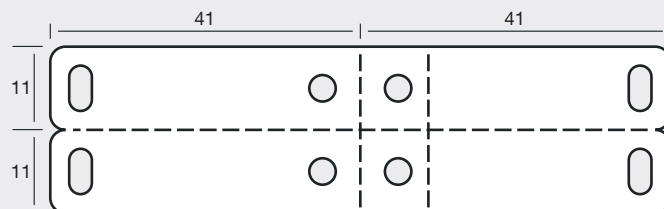

**45 2288\***

B = 1, BB = 120 mm, T = 6/6"

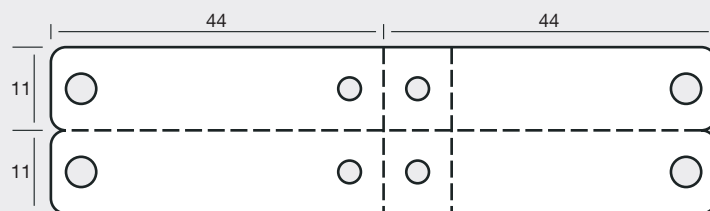

**45 1335\***

B = 3, BB = 130 mm, T = 3/6"  
für nicht selbstklebende  
Papiere, Folien und Ver-  
bundfolien |  
for non-adhesive papers,  
foils and compound foils |  
pour papiers, pellicules  
et composites non auto-  
collants

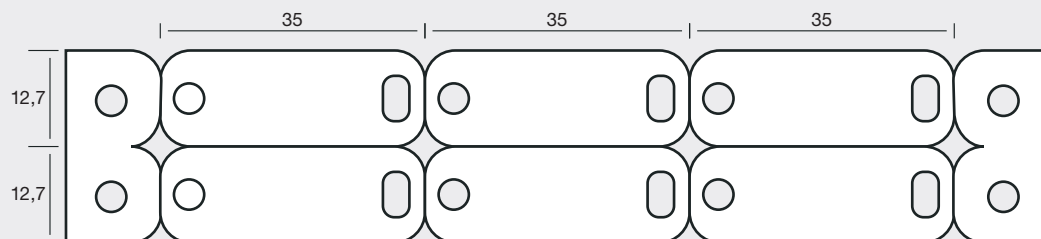

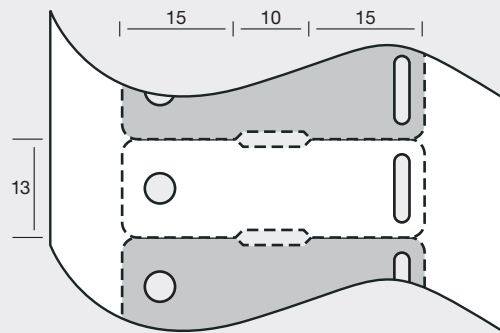

**35 1340/2\***

B = 1, BB = 40 mm

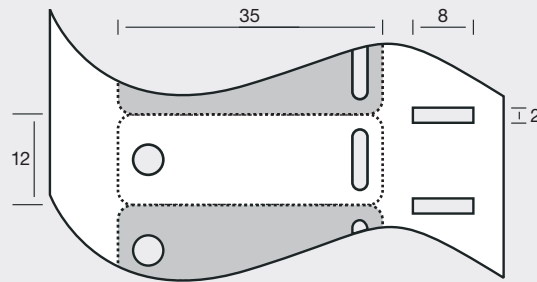

**35 1235\***

B = 1, BB = 60 mm, T = ∅

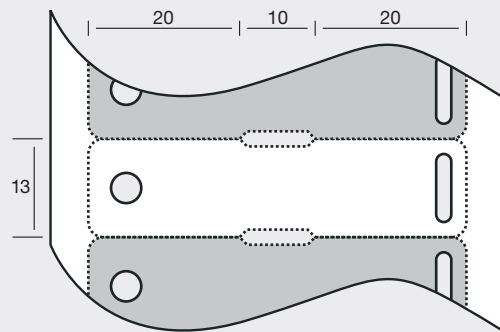

**35 1350\***

B = 1, BB = 50 mm

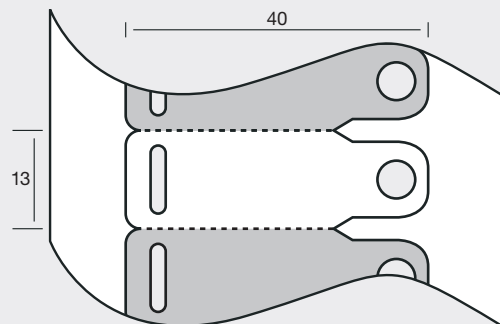

**35 1340/1\***

B = 1, BB = 40 mm

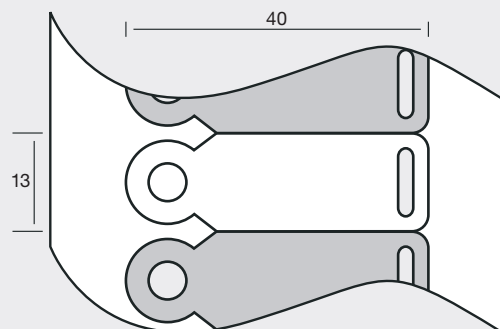

**35 1340\***

B = 1, BB = 40 mm

*Etikett mit mikroperforierter Kontur für nicht selbstklebende Papiere, Folien und Verbundfolie, mit Führungsloch für Thermotransfer-Drucker |*

*Label with micro-perforated outline for non-adhesive papers, foils and compound foils with guide hole for thermal transfer printers |*

*Etiquette à contours microperforés pour papiers, pellicules et composites non autocollants, avec trou de guidage pour imprimante transfert thermique*